



UNPOLISHED TUBE OD FITTINGS....

Unpolished Tube OD Weld Fittings are used in a wide variety of industrial applications where sanitary finishes are not generally required. VNE's tumbled finish presents a consistent uniform appearance.

VNE's Unpolished Weld Fittings are offered in nominal tube sizes 1/2" through 8" in T304 and T316L materials. Uniform wall thickness for 1/2" through 3" sizes measure .065 (16 ga). In 4" size, wall thickness measure .083 (14 ga), 6" and 8" .109 (12 ga).

TUBE OD FITTING SPECIFICATIONS....

Size Range: 1/2" OD through 8" OD

Materials: T304
T316L

Finish: Unpolished - Tumbled

ORDERING SPECIFICATIONS....

Specify:

- Quantity
- Product description or Part No.
- Size
- Material Type
- Polish Requirements

LIMITED WARRANTY....

VNE Corporation products are warranted to be free from defects in material and workmanship for a period of one year from the date of shipment. Any product that proves to be defective shall be repaired or replaced at the option of VNE, providing it has been used as recommended and in strict accordance with recognized piping practices, and that has not been subject to extraordinary service, such as encountered under severe corrosive or abrasive conditions.

VNE makes no warranties, express or implied, other than those listed above.

VNE shall not be liable for any consequential, indirect, incidental or contingent damages.

UNPOLISHED TUBE OD FITTINGS

V2WC - 90° ELBOW LESS TANGENTS

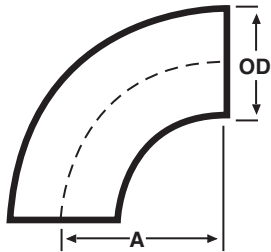

Size Tube OD	A	Nom. Wall
1/2	0.750	0.065
3/4	1.125	0.065
1	1.500	0.065
1 1/4	1.875	0.065
1 1/2	2.250	0.065
2	3.000	0.065
2 1/2	3.750	0.065
3	4.500	0.065
4	6.000	0.083
6	9.000	0.109
8	12.000	0.109

V2S - 90° ELBOW WITH TANGENTS

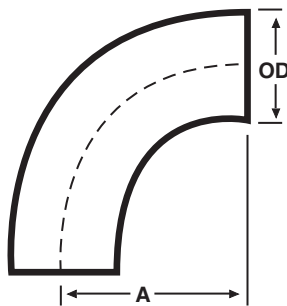

Size Tube OD	A	Nom. Wall
1	2.062	0.065
1 1/2	2.937	0.065
2	4.062	0.065
2 1/2	5.187	0.065
3	6.312	0.065
4	8.312	0.083

V2WU - 180° U BEND

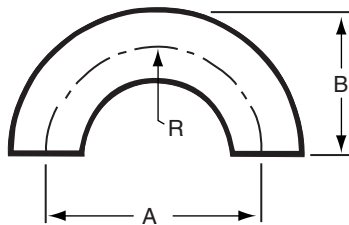

Size Tube OD	A	B	C	R	Nom. Wall
1/2	1.500	1.000	0.500	0.750	0.065
3/4	2.250	1.500	0.750	1.125	0.065
1	3.000	2.000	1.000	1.500	0.065
1 1/4	3.750	2.500	1.250	1.875	0.065
1 1/2	4.500	3.000	1.500	2.250	0.065
2	6.000	4.000	2.000	3.000	0.065
2 1/2	7.500	5.000	2.500	3.750	0.065
3	9.000	6.000	3.000	4.500	0.065
4	12.000	8.000	4.000	6.000	0.083
6	18.000	12.000	6.000	9.000	0.109

UNPOLISHED TUBE OD FITTINGS

STAINLESS STEEL FITTINGS
PRODUCT CATALOG

V2WK - 45° ELBOW LESS TANGENTS

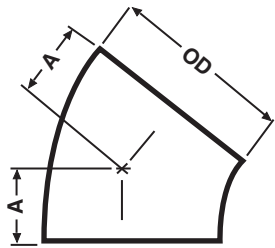

Size Tube OD	A	Nom. Wall
1/2	0.312	0.065
3/4	0.468	0.065
1	0.625	0.065
1 1/4	0.781	0.065
1 1/2	0.937	0.065
2	1.250	0.065
2 1/2	1.562	0.065
3	1.875	0.065
4	2.500	0.083
6	3.750	0.109
8	5.000	0.109

V2KS - 45° ELBOW WITH TANGENTS

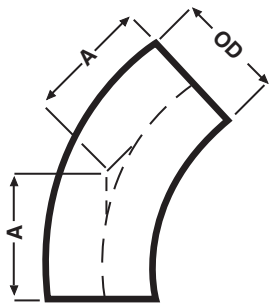

Size Tube OD	A	Nom. Wall
1	1.187	0.065
1 1/2	1.625	0.065
2	2.312	0.065
2 1/2	3.000	0.065
3	3.687	0.065
4	4.812	0.083

V7W - LONG TEE

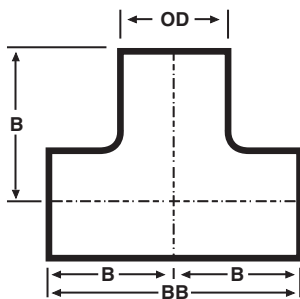

Size Tube OD	B	BB	Nom. Wall
1/2	CONTACT VNE		
3/4	CONTACT VNE		
1	1.875	3.750	0.065
1 1/2	2.250	4.500	0.065
1 1/4	2.250	4.500	0.065
2	3.000	6.000	0.065
2 1/2	3.000	6.000	0.065
3	3.250	6.500	0.065
4	3.875	7.750	0.083
6	5.625	11.250	0.109
8	7.000	14.000	0.109

V7WWW - SHORT TEE

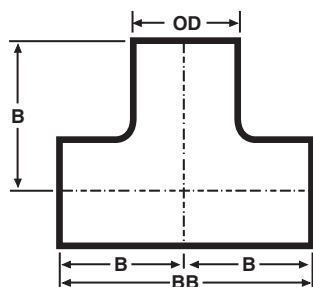

Size Tube OD	B	BB	Nom. Wall
1	1.125	2.250	0.065
1 1/2	1.656	3.312	0.065
2	2.062	4.125	0.065
2 1/2	2.343	4.687	0.065
3	2.593	5.187	0.065
4	3.430	6.875	0.083
6	5.625	11.250	0.109
8	7.000	14.000	0.109

UNPOLISHED TUBE OD FITTINGS

STAINLESS STEEL FITTINGS
PRODUCT CATALOG

V7WR - REDUCING TEE

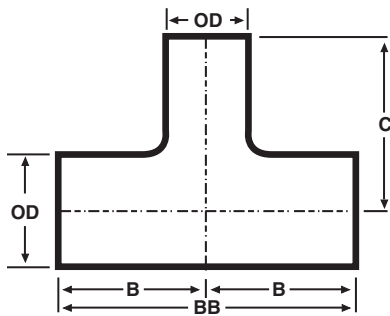

Size Tube OD	BB	C	B	Nom. Wall Run
3/4 x 1/2	CONTACT VNE			0.065
1 x 1/2				0.065
1 x 3/4				0.065
1 1/2 x 1/2				0.065
1 1/2 x 3/4				0.065
1 1/2 x 1	4.500	2.125	2.250	0.065
2 x 1	6.000	2.375	3.000	0.065
2 x 1 1/2	6.000	2.500	3.000	0.065
2 1/2 x 1 1/2	6.000	2.750	3.000	0.065
2 1/2 x 2	6.000	3.250	3.000	0.065
3 x 1 1/2	6.480	3.000	3.250	0.065
3 x 2	6.480	3.500	3.250	0.065
3 x 2 1/2	6.480	3.250	3.250	0.065
4 x 2	7.750	4.000	3.875	0.083
4 x 2 1/2	7.750	3.750	3.875	0.083
4 x 3	7.750	3.750	3.875	0.083
6 x 2	11.250	5.625	5.625	0.109
6 x 3	11.250	5.625	5.625	0.109
6 x 4	11.250	5.625	5.625	0.109

V9W - CROSS

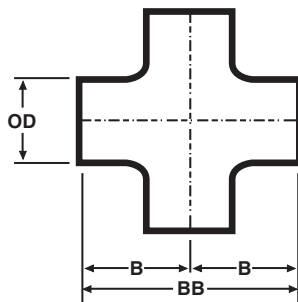

Size Tube OD	B	BB	Nom. Wall
1/2	CONTACT VNE		0.065
3/4			0.065
1	1.875	3.750	0.065
1 1/2	2.250	4.500	0.065
1 1/4	2.250	4.500	0.065
2	3.000	6.000	0.065
2 1/2	3.000	6.000	0.065
3	3.250	6.500	0.065
4	3.875	7.750	0.083
6	5.625	11.250	0.109

V14WA - TYPE A STUB END WITH GROOVES

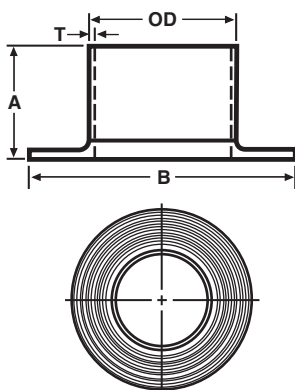

Size Tube OD	A	B	Nom. Wall (T)
1/2	1.625	1.625	0.065
3/4	1.375	1.687	0.065
1	1.625	2.000	0.065
1 1/4	1.375	2.500	0.065
1 1/2	1.750	2.875	0.065
2	1.500	3.625	0.065
2 1/2	2.000	4.125	0.065
3	2.250	5.000	0.065
4	2.625	6.187	0.083
6	3.000	8.500	0.109

UNPOLISHED TUBE OD FITTINGS

STAINLESS STEEL FITTINGS
PRODUCT CATALOG

V16W - WELD CAP

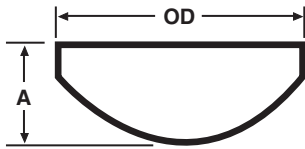

Size Tube OD	A	Nom. Wall
1/2	0.250	0.065
3/4	0.312	0.065
1	0.375	0.065
1 1/4	0.500	0.065
1 1/2	0.562	0.065
2	0.750	0.065
2 1/2	1.000	0.065
3	1.250	0.065
4	1.500	0.083
6	Contact VNE for dimensions	
8		

19WB / *19WBF - MALE NPT X WELD ADAPTER

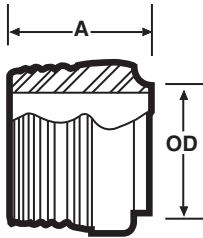

Size Tube OD	A	Nom. Wall
1/2	1.625	0.065
3/4	1.625	0.065
1	1.750	0.065
1 1/4	1.750	0.065
1 1/2	1.750	0.065
2	1.812	0.065
2 1/2	2.312	0.065
3	2.500	0.065
4	2.562	0.083
6	4.000	0.109

***19WBF - 1 inch through 4 inch are supplied with wrench flats**

22WB / *22WBF - FEMALE NPT X WELD ADAPTER

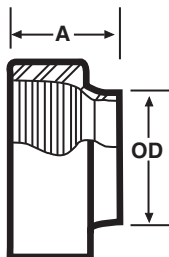

Size Tube OD	A	Nom. Wall
1/2	1.125	0.065
3/4	1.125	0.065
1	1.125	0.065
1 1/4	1.437	0.065
1 1/2	1.437	0.065
2	1.437	0.065
2 1/2	1.625	0.065
3	1.812	0.065
4	2.000	0.083

***22WBF - 1 inch through 4 inch are supplied with wrench flats**

UNPOLISHED TUBE OD FITTINGS

STAINLESS STEEL FITTINGS
PRODUCT CATALOG

V28WA - 45° LATERAL

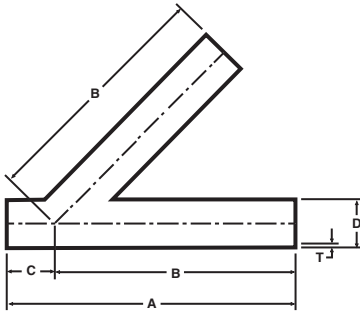

Size Tube OD	A	B	C	D	Nom. Wall (T)
1	6.000	5.000	1.000	1.000	0.065
1 1/2	7.375	6.187	1.187	1.500	0.065
2	8.625	7.125	1.500	2.000	0.065
2 1/2	10.125	8.500	1.625	2.500	0.065
3	10.750	8.875	1.875	3.000	0.065
4	12.812	10.750	2.062	4.000	0.083
6	18.000	14.500	3.500	6.000	0.109

V28WB - TRUE Y

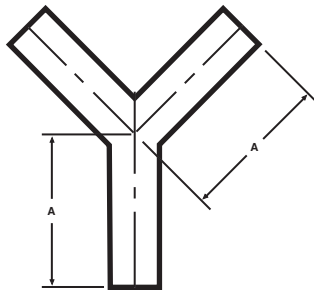

Size Tube OD	A
1	3.000
1 1/2	3.000
2	4.000
2 1/2	5.000
3	6.000
4	8.000
6	8.000

V31W - CONCENTRIC REDUCER

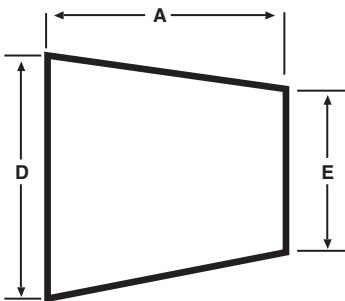

Size Tube OD D x E	A	Nom. Wall
3/4 x 1/2	*	0.065
1 x 1/2	*	0.065
1 x 3/4	*	0.065
1 1/2 x 1/2	*	0.065
1 1/2 x 3/4	*	0.065
1 1/2 x 1	2.000	0.065
1 1/2 x 1 1/4	1.000	0.065
2 x 1	4.000	0.065
2 x 1 1/4	3.000	0.065
2 x 1 1/2	2.000	0.065
2 1/2 x 1 1/2	4.000	0.065
2 1/2 x 2	2.000	0.065
3 x 1 1/2	6.000	0.065
3 x 2	4.000	0.065
3 x 2 1/2	2.000	0.065
4 x 2	8.000	0.083 x 0.065
4 x 2 1/2	6.000	0.083 x 0.065
4 x 3	4.000	0.083 x 0.065
6 x 3	5.500	0.109 x 0.083
6 x 4	5.500	0.109 x 0.083

* Contact VNE for Exact Dimensions.

UNPOLISHED TUBE OD FITTINGS

V32W - ECCENTRIC REDUCER

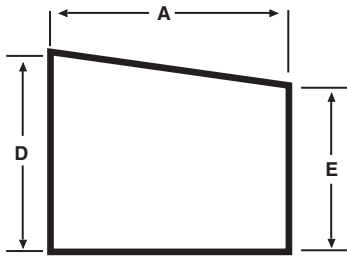

Size Tube OD D x E	A	Nom. Wall
3/4 x 1/2	*	0.065
1 x 1/2	*	0.065
1 x 3/4	*	0.065
1 1/2 x 1/2	*	0.065
1 1/2 x 3/4	*	0.065
1 1/2 x 1	2.000	0.065
1 1/2 x 1 1/4	1.000	0.065
2 x 1	4.000	0.065
2 x 1 1/4	3.000	0.065
2 x 1 1/2	2.000	0.065
2 1/2 x 1 1/2	4.000	0.065
2 1/2 x 2	2.000	0.065
3 x 1 1/2	6.000	0.065
3 x 2	4.000	0.065
3 x 2 1/2	2.000	0.065
4 x 2	8.000	0.083 x 0.065
4 x 2 1/2	6.000	0.083 x 0.065
4 x 3	4.000	0.083 x 0.065
6 x 3	5.500	0.109 x 0.083
6 x 4	5.500	0.109 x 0.083

* Contact VNE for Exact Dimensions.

E38SL - SLIP ON FLANGE

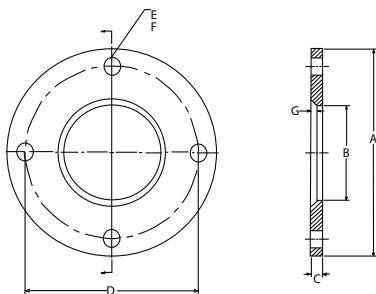

Size Tube OD	A	B	C	D	E	F	G
1/2	3.500	0.56	0.375	2.375	0.625	4.000	0.188
3/4	3.875	0.81	0.375	2.075	0.625	4.000	0.188
1	4.025	1.06	0.375	3.125	0.625	4.000	0.188
1 1/2	5.000	1.56	0.375	3.875	0.625	4.000	0.188
2	6.000	2.06	0.4375	4.075	0.075	4.000	0.219
2 1/2	7.000	2.56	0.4375	5.500	0.075	4.000	0.219
3	7.500	3.06	0.500	6.000	0.075	4.000	0.250
4	9.000	4.06	0.500	7.500	0.075	8.000	0.250
6	11.00	6.06	0.813	9.500	0.875	8.000	0.250

V14RH - 6L B/W Rubber Hose Barb Blank #1

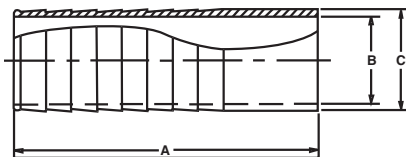

Size Tube OD	A	B	C
1/4	1.500	0.152	0.250
5/16	1.500	0.182	0.312
3/8	1.500	0.250	0.375
1/2	1.500	0.375	0.500
5/8	1.500	0.495	0.625
3/4	1.500	0.620	0.750
1	3.000	0.870	1.000
1 1/4	3.000	1.120	1.250
1 1/2	3.000	1.370	1.500
2	3.000	1.870	2.000
2 1/2	3.000	2.370	2.500
3	3.000	2.870	3.000